



Founded in 1946

Operational Maintenance & Service Bulletin for Models:



NHPL-1836-ECOC



INHPL-1825-UNC-DGT

NHPL-1836C-DGT

NHPL-1836-ECOC

Non-Insulated Standard

NHPL-1825-UNC-DGT

NHPL-1825-UNC

Non-Insulated Universal Runner

NHPL-1810HHC

Non-Insulated Undercounter 1/2 size

INHPL-1836C-DGT

INHPL-1836C

Insulated Standard

INHPL-1825-UNC-DGT

INHPL-1825-UNC

Insulated Universal Runner

INHPL-2416-PBCAB-DGT

Insulated Pass-Through



100% Pre-Tested Electrical Assembly



General Information

Models:

NHPL-1836C-DGT
NHPL-1836-ECOC
NHPL-1825-UNC-DGT
NHPL-1825-UNC
NHPL-1810/HHC
INHPL-1836C-DGT
INHPL-1836C
INHPL-1825-UNC-DGT
INHPL-1825-UNC
INHPL-2416-PBCAB-DGT

TABLE OF CONTENTS

General Information	1
Unpacking and Installing	1
Maintenance and Caution	1
Power Supply	1
Operating Instructions Digital Drawer	2
Alarms and Conditions.....	6
Operating Instructions Analog Controls	8
Service Specifications	8
Recommended Temperature Guidelines-Food holding Chart	9
Drawer Assembly and Parts	10
Electric Schematic Power Supply NHP-PD-DGT Digital	11
Electric Schematic Power Supply NHP-PD-ECO Analog.....	12
Universal Runner Assembly Instructions.....	13
Field Reversible Door Instructions	14
INHPL-2416-PBCAB-DGT Field Reversible Door Instructions.....	17
Statement of Warranty & Troubleshooting	18

General Information

Our Heater Proofer Series cabinet will hold food hot at a constant temperature and supply humidity for proofing when the application applies. This cabinet is NOT a cooking appliance.

UNPACKING

Examine the interior of the unit to make sure all packing materials are removed before the unit is plugged into an electrical outlet. Examine the interior and exterior to determine whether any damage was incurred during delivery. If so, notify the carrier immediately to file a damage claim. All WinHolt equipment is carefully tested and inspected prior to shipment. When accepted for delivery by carrier, the responsibility for safe arrival at the destination is assumed by the carrier. For the INHPL-1825-UNC, and INHPL-1825-UNC-DGT universal runners are boxed separately and found inside the cabinet.

CAUTION

Should any damage be found, do not attempt to operate the unit. Call your dealer IMMEDIATELY to arrange for service.

INSTALLATION

Position your unit on a stable level surface and plug in the supplied cord into any grounded 120-volt AC, 15 amps power supply dedicated breaker. It does not require a dedicated circuit but is designed for use with the power cord supplied with the unit. It is highly recommended that you use ONLY the power cord supplied. Use of a dedicated circuit should insure operational efficiency. Do not operate the unit with an extension cord.

MAINTENANCE

The equipment has been designed to require minimum maintenance and has been constructed to meet NSF and U.S. Public Health Service standards.

Non-toxic chemical cleaners or mild detergents are recommended for cleaning of fixtures.

DO NOT use steel wools of any kind. Steel wool particles will work into the grains of the metal causing corrosion. Also, these particles can cause a health hazard. Should scouring be required, use a non-abrasive type of cleaner. Do not use caustic solutions on your equipment. Hosing or steam cleaning should not be necessary to keep these fixtures clean and sanitary. Do not allow water or steam to come into contact with electrical components. Never power wash or steam clean the cabinet with the power drawer inserted.

POWER SUPPLY (NHP-PD-ECO Analog Drawer or NHP-PD-DGT Digital Drawer)

The the units do not require a dedicated circuit but is designed for use with the power cord which is supplied. It is highly recommended that you use ONLY the power cord supplied. Use of a dedicated circuit should insure operational efficiency. Do not operate the unit with an extension cord.

CAUTION

Be sure to disconnect power source before cleaning and servicing the unit. Liability for improper or careless use is the responsibility of the equipment owner or persons servicing the unit, including the authorized service agent.

Operating Instructions For Digital Drawer DGT Series

TURNING ON THE UNIT

See page 8 for Analog Drawer Operation

When the unit is first plugged in, the control:

- Emits one short beep
- Executes a lamp test for 5 seconds
- Turns “OFF” all indicators
- Turns unit to the “OFF” mode. In this mode the control remains powered as long as the unit is plugged in, it is not truly off, but the blower and all heaters are off.

TURNING ON THE CONTROL

The Control is turned “ON” by pressing and holding the POWER button for at least 2 seconds. A beep will occur when first pressed and “Hld” and “Hld” will be displayed on the 3-digit displays indicating “HOLD”. The same process is used to return the Control to “OFF” mode from “IDLE”, “HEAT”, or “PROOF” mode.

When the Control is first turned “ON”, it enters “IDLE” mode with the “POWER LED” on and the “HEAT” and all “PROOF LED” off.

The 3-digit displays will show “---” and “---” indicating the Control is “ON”, but not yet controlling Heat or Humidity [Temperature].

MODE SELECTION

“HEAT” Mode

To select “HEAT” mode, press the “HEAT” button while in “IDLE” or “PROOF” mode.

The “HEAT LED” will turn on, the Heat Mode Box Temperature Setpoint will be displayed (blinking), and the unit will control Box Temperature based on the displayed setpoint. After 10 seconds, the display will change to show the Actual Box Temperature.

To return to “IDLE”, press the “HEAT” button again; the “HEAT LED” will turn “OFF” and Box Temperature Control will cease. The Heat Mode Box Temperature Setpoint is stored and will be used the next time “HEAT” mode is entered

“PROOF” Mode

To select “PROOF” mode, press the “PROOF” button while in “IDLE” or “HEAT” mode.

The “PROOF LED” will turn on, the Proof Mode Box Temperature and Humidity [Temperature] Setpoints will be displayed (blinking), and the unit will control Box Temperature and Humidity (Water Pan Temperature) based on the displayed setpoints.

Even though the Humidity Setpoint is managed as an “N” index, actual temperature is displayed in °F or °C, as configured.

To return to “IDLE”, press the “PROOF” button again; the “PROOF LED” will turn off and Box Temperature and Humidity [Temperature] Control will cease. Proof Mode Box Temperature and Humidity Setpoints are stored and will be used the next time “PROOF” mode is entered.

NOTE: Box Temperature Setpoint limits are the same in “PROOF” mode as in “HEAT” mode. The user could set a high box temp even though the humidity setpoint is low.

Operating Instructions (continued)

CONTROLS

TURNING “OFF” THE CONTROL

To turn “OFF” the Control, press and hold the “POWER” button, the Control stores the (“IDLE”, “HEAT”, or “PROOF”) Operating Mode.

When the Control is turned back “ON”, it automatically enters its previous mode. Along with separately stored “HEAT” and “PROOF” mode Box Temperature Setpoints.

This feature streamlines transitions between “HEAT”, “PROOF”, “IDLE”, and “OFF” modes.

BOX (CABINET) TEMPERATURE

Box (Cabinet) Temperature is indicated on the left-hand 3-digit display when in “HEAT” or “PROOF” mode.

The display can be configured for °F, °C, or “N” index-based format. If in “N” format, the “SETPOINT” is displayed as a numeric value from 1 through 9 and the actual temperature is displayed in °F, otherwise, both setpoint and actual temperature are displayed in the selected format.

Box Temperature Setpoint (see Table 2 for “N” index-based setpoints):

Table 1

	°F	°C	“N”
Minimum	80	26	1 (80 °F)
Maximum	190	88	9 (190 °F)
Resolution	5	2	1 (13.75 °F)

Table 2

“N” Indexed Format Box Temperature Setpoint Table		
“N”	°F	°C
1.0	80.00	26.67
2.0	93.75	34.31
3.0	107.50	41.94
4.0	121.25	49.58
5.0	135.00	57.22
6.0	148.75	64.86
7.0	162.50	72.50
8.0	176.25	80.14
9.0	190.00	87.78
°/”N”	13.75	7.64

Operating Instructions (continued)

BOX TEMPERATURE HEATER CONTROL

Table 1

Behavior / Selected Units	°F	°C	“N” Index
Heater(s) turn off (temperature increasing)	Setpoint + 2	Setpoint + 1	Setpoint + 2 °F
Heater(s) turn on (temperature decreasing)	Setpoint – 2	Setpoint – 1	Setpoint – 2 °F

The Control implements a three-stage power algorithm during Box Temperature Control to minimize power consumption, improve temperature consistency, and minimize relay cycles.

There are two Heaters available to heat the box: 900 W and 600 W.

There are three stages of heat that can be used:

Stage 1 = 600 W

Stage 2 = 900 W

Stage 3 = 900 W + 600 W = 1500 W.

When initially entering “HEAT” mode or if the user increases the “SETPOINT” while in “HEAT” mode, the Control uses Stage 3 to reach its setpoint as quickly as possible.

If, during any heating cycle, the setpoint is reached before 4 minutes elapse, the next heating cycle begins with the next lower stage.

If, during any heating cycle, the setpoint is not reached before 8 minutes elapse, the control immediately uses the next higher stage and the next heating cycle will begin with that higher stage.

Humidity [Temperature]

Humidity [Temperature] is indicated on the right-hand 3-digit display, **only** in “PROOF” mode.

Throughout this document, humidity refers to the Water Pan Temperature, since humidity is not directly sensed.

In “HEAT” mode, “---” is displayed. The Humidity Setpoint ranges from 1.0 through 9.0 with a resolution of 0.5. See Table 2.

Operating Instructions (continued)

Table 2

Humidity [temperature] Setpoint Table (“N” Indexed Only)		
"N"	°F	°C
1.0	100.00	37.78
1.5	103.13	39.51
2.0	106.25	41.25
2.5	109.38	42.99
3.0	112.50	44.72
3.5	115.63	46.46
4.0	118.75	48.19
4.5	121.88	49.93
5.0	125.00	51.67
5.5	128.13	53.40
6.0	131.25	55.14
6.5	134.38	56.88
7.0	137.50	58.61
7.5	140.63	60.35
8.0	143.75	62.08
8.5	146.88	63.82
9.0	150.00	65.56
°/"N"	6.25	3.47

HUMIDITY [TEMPERATURE] HEATER CONTROL

Table 1

Behavior / Selected Units	“N” Index
Heater turns off (temperature increasing)	Setpoint + 2 °F
Heater turns on (temperature decreasing)	Setpoint

When Setpoints are displayed, they are **always** flashing.

When Actual Temperatures are displayed, they are **always** steady.

To view/set a Temperature or Humidity “SETPOINT”, press the “UP” or “DOWN” button beneath the respective Temperature or Humidity Display.

The “SETPOINT” will flash and may be adjusted up or down to its limits using the “UP” or “DOWN” buttons.

When being adjusted, Setpoint(s) will remain flashing for 5 seconds while adjusting. After adjusting a steady display will show actual conditions.

Note: Humidity Setpoint may be set **only** in “PROOF” mode, **not** in “HEAT” mode.

Operating Instructions (continued)

READY INDICATORS FOR HEAT AND HUMIDITY

The Control provides two “READY” indicators for Heat and Humidity.

“READY” indicators are controlled separately and the Humidity Ready indicator will remain off in “HEAT” mode.

The Heat Ready / Proof Ready function operates as follows:

Behavior / Selected Units	°F	°C	“N” Index
LED turns on (temperature increasing)	Setpoint	Setpoint	Setpoint
LED turns off (temperature decreasing)	Setpoint – 10 °F	Setpoint – 6 °C	Setpoint – 10 °F

Alarms and Conditions

AUDIBLE INDICATORS

The Control provides audible indicators as follows:

One short beep: When power is first applied.

One short beep: When the “POWER” button is pressed while in “OFF” mode.

Three short beeps: Box Temperature or Humidity [Temperature] becomes “READY” and the “READY LED” turns “ON”.

One long beep: Box Temperature or Humidity [Temperature] transitions from “READY” to “NOT READY” and the “READY LED” turns “OFF”.

When an alarm condition is detected, as described below:

- The Control has a “LOW WATER” indicator which is not included. There is neither a sensor nor a detection technique implemented in its firmware. This red LED is illuminated during the Lamp Test Function only.
- The Circulating Blower is turned “ON” when the Control transitions from “OFF” to “IDLE”, “HEAT”, or “PROOF” mode and remains “ON” until the Control returns to “OFF”. The Blower remains “ON” in “IDLE” mode even though no heaters are on in that mode.
- The Control defaults to display in °F, but the display format is easily changed.

Turn the unit “OFF” by holding the “POWER” button, then hold both “POWER” and Box Temperature “DOWN” buttons until “Hld” turns off. At that point the currently selected display format will appear on the Temperature Display as “F”, “C”, or “n”.

Use the temperature “UP” or “DOWN” buttons to scroll through the format options to change the format. When the desired format is displayed, stop pressing buttons and wait 10 seconds for the Control to return to the mode prior to being turned off. The selected format will be remembered even if power is removed.

- Firmware Version 0.4 adds the option to view the Control’s Firmware Version on the 3-digit displays.

Turn the unit “OFF” by holding the “POWER” button, then hold both “POWER” and

Alarms and Conditions (continued)

Humidity Temperature “DOWN” buttons until “Hld” turns off.

The Firmware Major Version will be displayed on the Heat Temperature Numeric Display, along with a trailing decimal point.

The Firmware Minor Version will be displayed on the Humidity Temperature Numeric Display.

After 10 seconds the control will return to the mode prior to being turned off.

- If an Alarm Condition is detected, the beeper sounds for 0.5 second and then is off for 1 second. This repeats until acknowledged (silenced).

To acknowledge (silence) the alarm, a short press of the “POWER” button is all that is required.

The Alarm Condition may persist, but the beeper will remain silenced until another alarm condition occurs.

- In addition to the audible alarm, the two 3-digit displays provide information about the cause of the alarm as shown in the following table. If an Alarm Condition is detected but goes away before being acknowledged, its indication will continue until being acknowledged.

Fault Detected	Detection Method	Indication	Effect on Operation
Pushbutton stuck	Pushbutton actuated longer than 30 seconds	“Err” “Pbn” pushbutton “n” stuck where “n” is 1 = power; 2 = heat; 3 = proof; 4 = heat up; 5 = heat down; 6 = [proof] humidity up; 7 = [proof] humidity down	None – stuck pushbutton is ignored
Box temperature Thermistor shorted	Thermistor resistance out of range too low	“Err” “5I5” sensor 1 short	Box Heater(s) are turned off
Box temperature Thermistor open	Thermistor resistance out of range too high	“Err” “5I0” sensor 1 open	Box Heater(s) are turned off
Water temperature Thermistor shorted	Thermistor resistance out of range too low	“Err” “525” sensor 2 short	Water Heater is turned off
Water temperature Thermistor open	Thermistor resistance out of range too high	“Err” “520” sensor 2 open	Water Heater is turned off
No AC Line Interrupt	60 Hz (16.67 ms interval) interrupt has not occurred within 50 ms	“Err” “AC ” AC interrupt	Timed relay operations are suspended; relay operations lose AC line synchronization

Operating Instructions For Analog Drawer Series C Series

1. Push main power switch (ON/ OFF rocker) to “ON” position.
2. Push HEAT/ PROOF switch to HEAT for heating ONLY.
3. Turn HEAT thermostat knob fully clockwise for preheat.
4. Allow 45 minutes for pre-heating, then turn thermostat to desired setting.
5. Place water in the “water pan” filling to about 3/4 full, for proofing
6. For proofing, push HEAT/ PROOF switch to PROOF.
7. Adjust the heat and humidity thermostat knob to control desired temperature and humidity. Allow 45 minutes for pre-heating.

NOTE: The internal air circulation blower and 900w heater element (controlled with the “Heat” Thermostat) will operate continuously when the power switch is turned “ON”.

HEAT THERMOSTAT

The controlling range is 80°F to 185°F. The dial has numbers 1 thru 9 that do not relate to a specific calibrated temperature. Temperature settings must be obtained through familiarization with the unit. The dial also has an “OFF” position to turn heater unit off.

HUMIDITY THERMOSTAT

To control humidity range from 30% to 100%, humidity settings must be obtained through familiarization with the unit. The dial has numbers 1 thru 9 that do not relate to a specific calibrated humidity. The dial also has an “OFF” position to turn humidity off.

To maintain low heat range between 85°F and 100°F, switch to proof mode and adjust heat knob to desired heat range. Allow 45 minutes to pre-heat in proof cycle.

Service Specifications

Heater Proofer Series

The Heater-Proofer is an aluminum transport cabinet with heaters to function as a hot food holding cabinet, and/or as a proofing cabinet.

The heater, or heat drawer, is slid into place on the lower ledges of the cabinet. An electrical power cord is provided and plugged into the drawer through an access hole in the back of the cabinet.

The main power switch on the front of the drawer, when switched “ON”, will turn on the light in the switch and turn on the air circulating fan in the drawer. The circulating fan and 900w heater element will operate continuously while the unit is “ON”.

Analog Drawer: The thermostat control knobs are mounted to the left and right of the HEAT/ PROOF switch. The left thermostat knob controls the heat in the cabinet from 1 (low heat; approx. 80 °F) to 9 (high heat; approx. 185 °F). The right thermostat knob controls the humidity from 1 (approx. 20% relative humidity) to 9 (100% relative humidity). Average setting will be approx. 6 (approx. 85% relative humidity).

Digital Drawer: The thermostat control buttons are located under each digital display “Heat Temperature” or “Proof Temperature”. The heat controls in the cabinet range from low heat approx. 80 °F to high heat, approximately 185 °F. The humidity controls in the cabinet range from approximately 20% to 100% relative humidity. The average will be approximately 85% relative humidity.

Recommended Temperature Guidelines

Food Holding Chart

Food Product	Covered Or Uncovered	Temperature F° f
Biscuit	Uncovered	180
Broccoli	Covered	170 - 175
Chicken Fried	Uncovered	180 - 185
Chicken Nuggets	Uncovered	175
Chicken Whole	Uncovered	170 - 180
Corn on the Cob	Covered	170 - 175
Croissants	Uncovered	175
Egg Patties	Covered	180
Fish Baked	Uncovered	175
Fish Fried	Uncovered	180
French Fries	Uncovered	185
Hamburgers	Covered	180
Lasagna	Covered	185
Potatoes Baked	Uncovered	180
Potatoes Mashed	Covered	175
Potatoes Scalloped	Covered	175
Pancakes	Covered	175
Pasta	Covered	180
Peas	Covered	170 - 175
Pizza	Uncovered	175 - 180
Roast Beef	Uncovered	170 - 180
Roast Pork	Uncovered	170 - 180
Strip Steak	Uncovered	160 - 170
Turkey	Uncovered	170 - 180
Vegetables Mixed	Covered	170 - 175
Waffles	Covered	175

Heater Proofer Replacement Parts

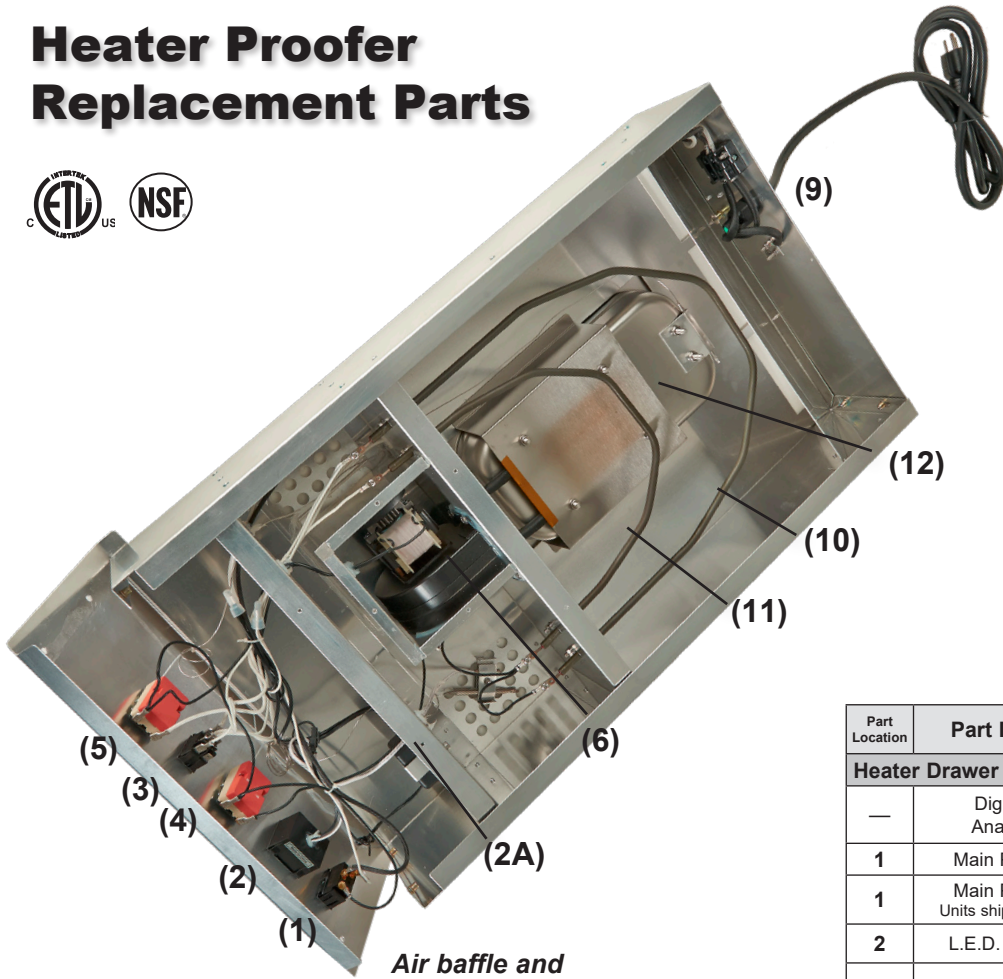

Drawer view from upside down with bottom cover removed.

*Removable Drawers
Makes Cleaning Quick & Easy*

**HEATER PROOFER
POWER SUPPLY
120VAC 60Hz
13.5 AMP**

Air baffle and circulating air blower provide even heat distribution.

**NHP-PD-ECO
Analog Drawer**

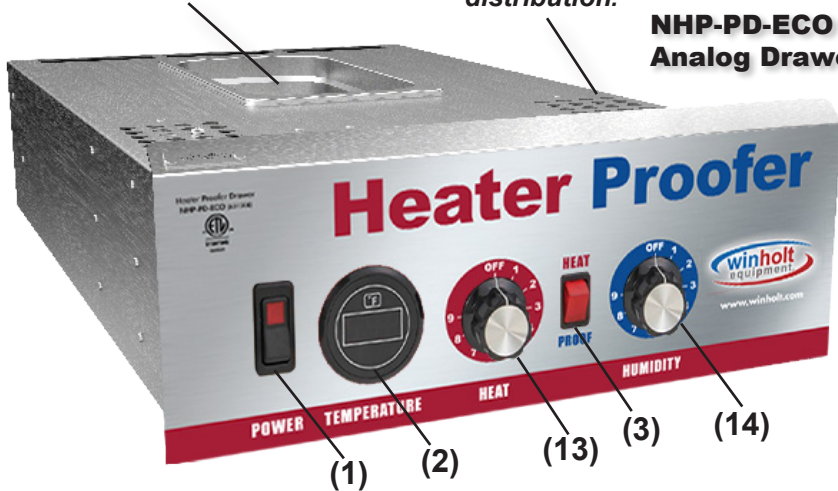

**NHP-PD-DGT
Digital Drawer**



Part Location	Part Description	Order#	Model#
Heater Drawer Parts List			
—	Digital Drawer Analog Drawer	1069296 631208	NHP-PD-DGT NHP-PD-ECO
1	Main Power Switch	637108	H-106-2B
1	Main Power Switch Units shipped after 5.2013	987124	H-106-2C
2	L.E.D. Thermometer	123887	H-105
2A	Thermometer Transformer		
3	Heat/Proof Switch	232784	H-106-1
9	Power Inlet	123908	H-107
4	Thermostat (Heat)	170851	H-220
5	Thermostat (Proof)		
6	Blower & Motor Assembly	637095	H-225-B
10	900W Heater Element	170907	H-226
11	600W Heater Element	170915	H-227
12	600W Water Pan Heater Element	170923	H-228
12A	Water Pan w/ Studs	696482	H-242
13	Heat Control Knob	123916	H-108
14	Proofer Control Knob		
15	Circuit Breaker	1081691	H-249
---	External Drip Pan	683665	WHPP6122.5D

Replacement power cord available at local home improvement stores

Cabinet Parts List		
Replacement Door Lexan 1836 Series	247505	NHPL-DR
Replacement Universal Runner (1)	657150	NHPL-1825-UN-RUNNER
Door Gasket for NHPL-1810HHC	681416	NHPL-1810/HH-DR GSKT
Door Gasket for NHPL-1825UNC	681328	NHPL1825-UN-DR GSKT
Door Gasket for 1836 Series	650484	NHPL1836-DR GSKT
Replacement Door Lexan Universal Runner	657459	NHPL-DR/UN
Replacement Door Lexan Mini Half Height	657432	NHPL-DR/HH
Plastic Door Handle	233656	H-323-2

Electric Schematic Power Supply

Digital Drawer NHP-PD-DGT

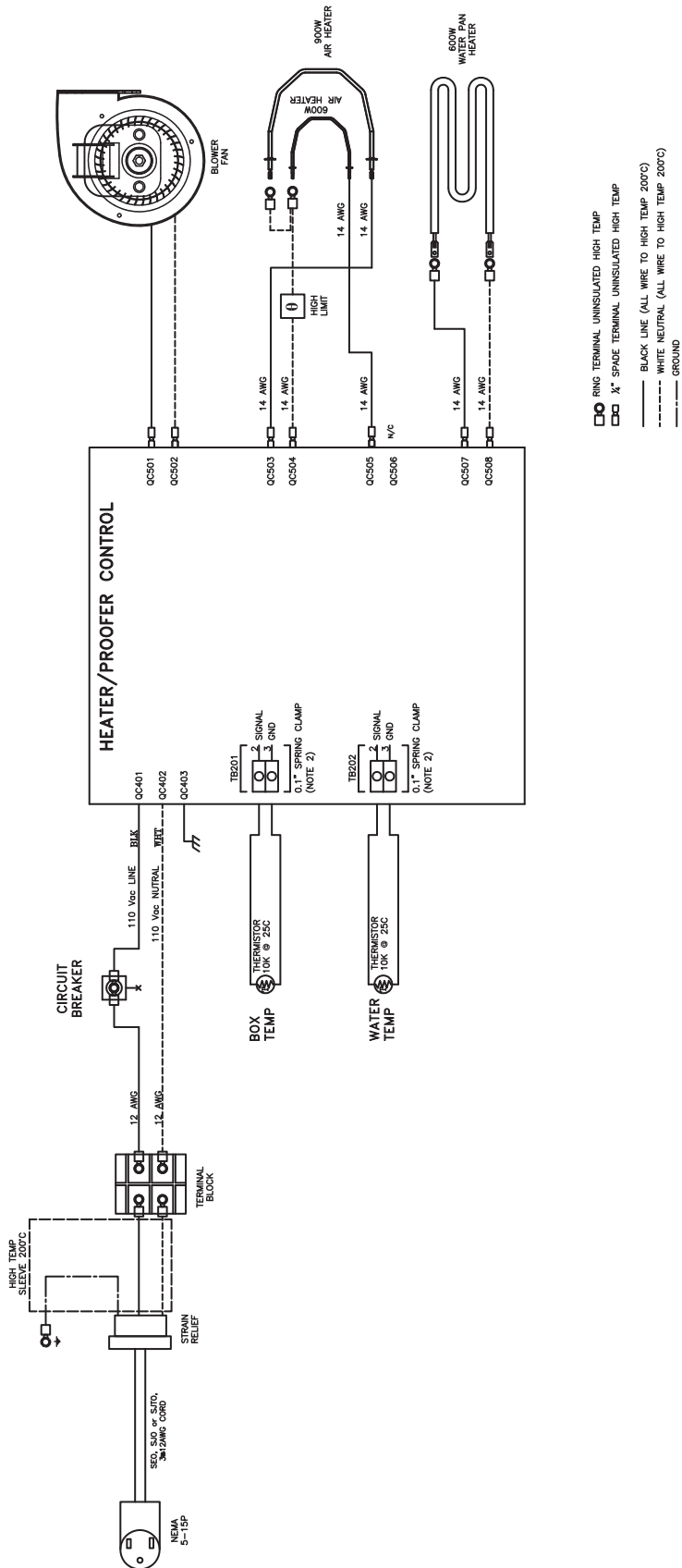

Electric Schematic Power Supply (continued)

Analog Drawer NHP-PD-ECO

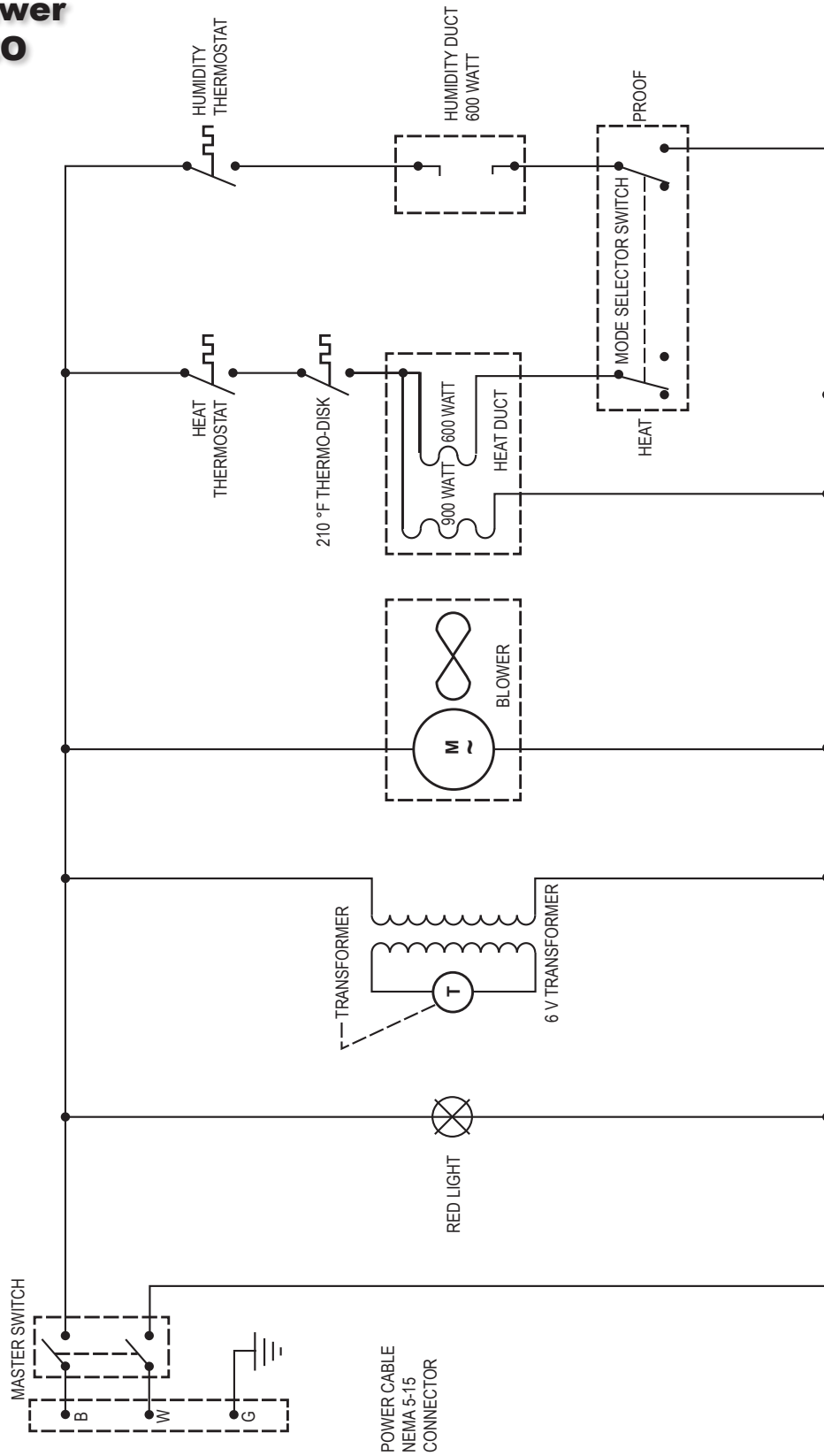

Universal Runner Assembly Instructions

NOTICE: WIRE RUNNER ASSEMBLY & REMOVAL PROCEDURE

NOTICE: Model INHPL-2416-PBCAB-DGT has (4) Removable Wire Runners

RUNNERS MUST BE ASSEMBLED WITH A 4" MINIMUM SPACE ABOVE THEM TO ASSEMBLE THE RUNNER



GRASP THE RUNNER AS SHOWN IN THE PHOTOS BELOW.



TILT THE RUNNER UP AND ENGAGE BOTH ENDS TOGETHER. DO NOT HAVE ONE SIDE ENGAGED LESS THAN THE OTHER.



ROTATE THE RUNNER DOWN APPLYING A SLIGHT FORCE INWARD AGAINST THE RUNNER AND CABINET. **DO NOT FORCE IT**



WHEN IN THE CORRECT POSITION THE RUNNER SHOULD BE AT 90 DEGREES TO THE SIDE OF THE CABINET.

RUNNERS MUST BE REMOVED WITH A 4" MINIMUM SPACE ABOVE THEM TO REMOVE A RUNNER



GRASP THE RUNNER AS SHOWN IN THE PHOTOS BELOW



TILT THE RUNNER UP SLOWLY WHILE PULLING THE RUNNER OUTWARD AWAY FROM THE SIDE OF THE CABINET.

DO NOT FORCE IT ASSURE BOTH SIDES ARE IN THE SAME POSITION AS YOU ARE LIFTING THE RUNNER



KEEP TILTING UNTIL THE RUNNER TOUCHES THE SLOTTED SIDE OF THE CABINET AND WITH BOTH ENDS OF THE RUNNER EQUAL DISTANT FROM THE CABINET SIDE THE RUNNER WILL SLIDE OUT EASILY. **DO NOT FORCE IT**

Field Reversible Door Instructions

Convert from Right Door to Left

NOTICE: See pages 20-21 for INHPL-2416-PBCAB-DGT field reversible door instructions.

Kit Includes:

- (2) Pair Universal Hinges

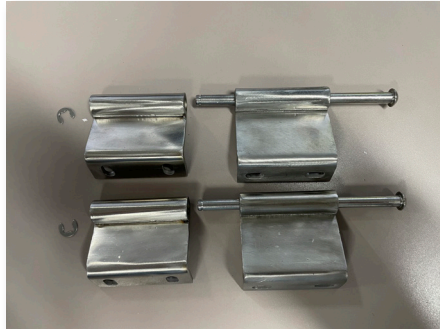

Tools Required:

- P2 Phillip Driver
- Drill Gun
- Needle Nose Plier



STEP 1

LIFT DOOR AND REMOVE, LAY IT ON A CLEAN AND SMOOTH SURFACE



STEP 2

REMOVE SCREWS AND HINGES FROM THE CABINET

Field Reversible Door Instructions Cont'd.

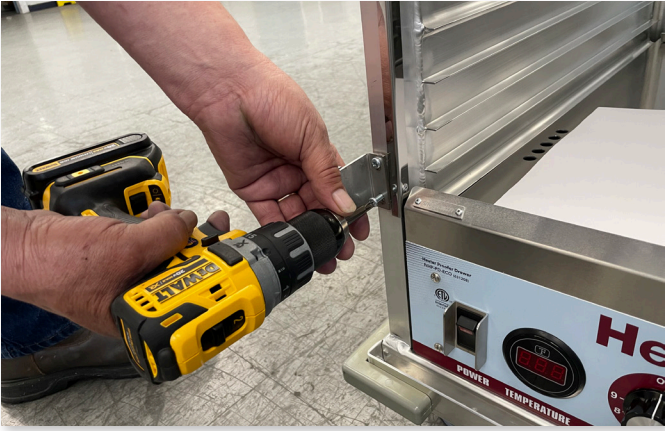

STEP 3
INSTALL HINGES AND SCREWS
ON THE LEFT (UPPER AND
LOWER)



STEP 4
REMOVE SCREWS AND HINGES
FROM DOOR



STEP 5
INSTALL UNIVERSAL D-HINGES
ON THE DOOR (DO NOT OVER-
TIGHTEN)



STEP 6
INSTALL DOOR TO THE CABINET
(LINE UP HINGES' PIN HOLE)

Field Reversible Door Instructions Cont'd.



STEP 7

INSERT HINGE PIN ON TOP HINGE



STEP 8

INSERT HINGE PIN ON LOWER HINGE,
THEN INSTALL E-CLIPS ON TOP AND
LOWER PINS



FINAL STEP

INSPECT DOOR HAS BEEN INSTALLED CORRECTLY

Model INHPL-2416-PBCAB-DGT

Field Reversible Door Instructions

PASS THROUGH HEATER PROFFER FIELD REVERSIBLE DOOR AND RACK REMOVAL INSTRUCTIONS
 TOOLS REQUIRED - P2 PHILLIP DRIVER AND A 5/16" SOCKET OR OPEN-END WRENCH

RIGHT HINGED DOOR CABINET

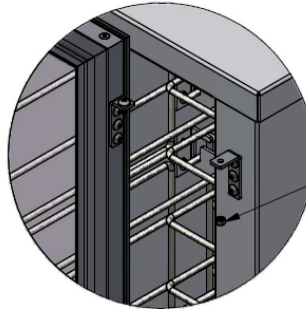
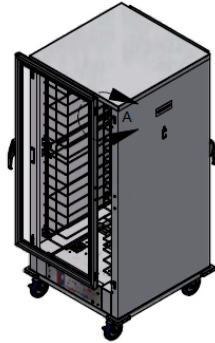
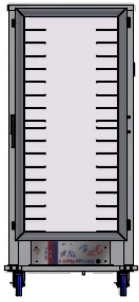

DETAIL A
SCALE 3/16

1. USE A 5/16" SOCKET OR WRENCH TO REMOVE THE LOWER AND UPPER HINGE NUT. LIFT DOOR UP AND OUT. LAY DOOR ON THE FLOOR OR TABLE.

CABINET HINGES

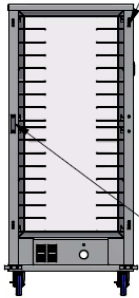

2. WITH PHILLIP DRIVER REMOVE ALL HINGE SCREWS FROM THE RIGHT SIDE. HOLD ON TO THE HINGES AND RE-ASSEMBLE THE SCREWS TO THE RIGHT SIDE EMPTY RIVET NUTS.

3. RE-ASSEMBLE THE HINGES TO THE LEFT SIDE OF THE CABINET USING THE EXISTING SCREWS ON THE LEFT SIDE.

4. REMOVE (2) DOOR CATCH SCREWS FROM THE LEFT SIDE. HOLD ON TO THE BRACKET AND RE-ASSEMBLE THE SCREWS TO THE EMPTY RIVET NUTS. RE-ASSEMBLE THE CATCH BRACKET TO THE RIGHT SIDE USING THE EXISTING SCREWS ON THE RIGHT SIDE.

CABINET HINGES

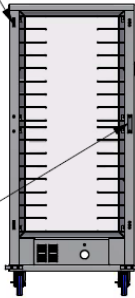

RIGHT HINGE DOOR

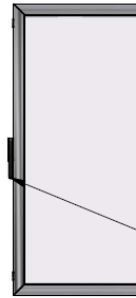

5. WITH PHILLIP DRIVER REMOVE ALL HINGE SCREWS FROM THE RIGHT SIDE. HOLD ON TO THE HINGES AND RE-ASSEMBLE THE SCREWS TO THE RIGHT SIDE RIVET NUTS.

6. RE-ASSEMBLE THE HINGES TO THE LEFT SIDE OF THE DOOR USING THE EXISTING SCREWS ON THE LEFT SIDE.

7. REMOVE HANDLE ON LEFT SIDE AND RE-ASSEMBLE ON THE RIGHT SIDE. SEE STEPS 8 AND 9 ON THE NEXT PAGE.

LEFT HINGE DOOR

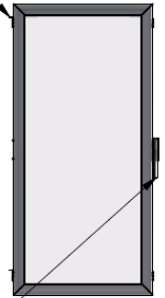

RIGHT HINGE DOOR

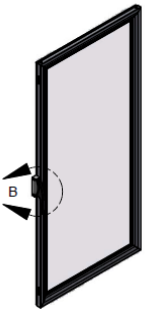

8. REMOVE PLASTIC CAPS FROM HANDLE BY PRESSING ONE END AND PRYING THE OTHER END OUT.

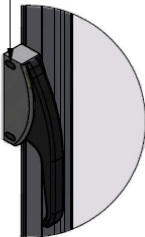

DETAIL B
SCALE 3/16

RIGHT HINGE DOOR

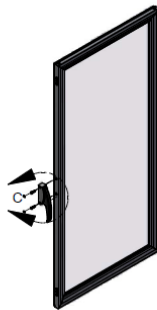

9. REMOVE THE SCREWS AND HANDLE FROM THE LEFT SIDE. RE-ASSEMBLE THE SCREWS TO THE LEFT SIDE DOOR RIVET NUTS. RE-ASSEMBLE THE HANDLE TO THE RIGHT SIDE IN REVERSE ORDER.

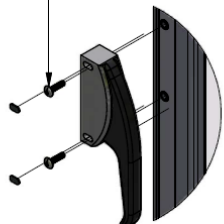

DETAIL C
SCALE 3/16

LEFT HINGE DOOR



LEFT HINGE DOOR CABINET

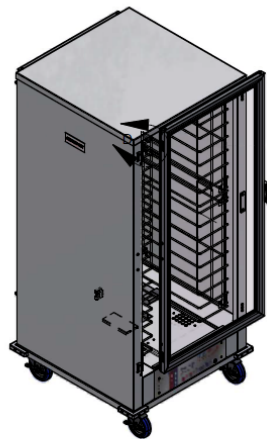

10. RE-HANG THE LEFT HINGE DOOR BY REPLACING THE UPPER AND LOWER DOOR HINGE SCREWS INTO THE TOP OF THE HINGES. ASSEMBLE THE DOOR TO THE CABINET HINGES.

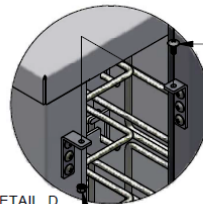

DETAIL D
SCALE 3/16

11. WITH THE 5/16 SOCKET OR WRENCH RE-FASTEN THE NUT TO BOTH THE UPPER AND LOWER HINGES.

Statement of Warranty

Winholt Power Equipment Warranty

Winholt warrants to the initial purchaser that all Winholt power equipment, including but not limited to Heater Proofers and Film Wrappers be free from defects in material or factory workmanship, under ordinary use for the purpose for which it is designed, for a period of (1) year from the date of shipment from the Winholt facility. Equipment will at our option be repaired or replacement part(s) furnished F.O.B. our factory. Warranty includes one (1) year labor from date of said shipment.

Return of component parts will not be accepted for credit without prior authorization of our Customer Care Department and then contingent upon our inspection. Warranty will not apply if, after examination, Winholt finds that the equipment or any part there of was found defective through lack of purchaser's responsibility for maintenance or storage, shipping damage, accidental damage by moving or otherwise, improper voltage, misapplication or alteration by anyone other than ourselves, or use of unauthorized parts. Warranty does not apply to glass, plastic, light bulbs, gaskets, or heater elements.

Prior to any service agency performing warranty labor, Winholt's Customer Care Department must be contacted to provide a "Service Authorization" (SA) number. Winholt assumes no responsibility for any charges that were not expressly authorized by it or for any charges that exceed in Winholt's sole judgement, normal and customary amounts. If service is required during overtime the difference between overtime and standard labor rates shall be paid by the purchaser. Warranty does not apply if payment has not been received for the equipment at the time a claim is made or if the Winholt serial number has been removed.

Warranty Exclusions and Limitations: Warranty applies only within the United States, equipment outside the United States shall have parts coverage only.

Administration of Warranty

For assistance in filing a claim, contact Winholt's Customer Care Department at 800.444.3595. Hablamos Español. All claims must be filed in writing and can be sent via: e-mail to customerservice141@winholt.com, faxed to 516-921-0538 or mailed to Winholt Equipment, 1169 North Great Southwest Parkway, Grand Prairie, Texas 75050, Attention: Customer Care Department. If deemed necessary by Winholt, the product must be returned to a Winholt factory designated by Winholt, at the owner's expense for inspection and approval of the claim.

Be sure you or your customer has the following information available when calling: Model Number, Name of Dealer, Serial Number and Installation Date

Troubleshooting

CAUTION

Before disassembling unit, electrical power must be disconnected by unplugging the unit. Failure to unplug the unit prior to servicing may result in electrical shock.

Each unit is shipped with an instruction manual and should be used as a reference guide for all service areas. The manual shows a picture of the drawer, showing the location of electrical components and a description of each. If the unit does not operate correctly, or malfunctions for any reason, the following check list should provide a solution.

1. Check to make sure "power cord" is firmly plugged into the wall outlet.
2. Check circuit breaker of wall outlet and reset if necessary.

IF unit fails to start, please do the following:

3. Remove heat drawer from cabinet. Remove bottom cover of drawer. Visually inspect to observe for:
 - a. Loose or disconnected wires
 - b. Black marks or burning on an components
 - c. Loose heating elements.
4. If any burn marks or discoloration of wires is noted on any component, the component along with all wires attached to the damaged component must be replaced.
5. If heater element is loose, or if it has broken loose from mounting tabs, the wires will short out on the metal, causing permanent damage. Both the element and main power switch (with wires on switch) must be replaced.
6. If temperature on "L.E.D. Thermometer" is not reading a constant temperature, it must be replaced along with its power supply transformer.